

PERGOLA

One of our exceptional products, designed as an architectural and structural element, is our PERGOLA.

It is built for outdoor use and adds a sophisticated and unique touch to any project while providing a pleasant atmosphere. The classic Pergola combines durability, elegance, and versatility, making it the best choice for creating shaded outdoor spaces such as gardens, walkways, and terraces in homes or buildings, thanks to its versatile options and combinations.

Specifications

- Can be freestanding or independent
- Can be attached to a building or another structure
- Different types of roofing: slatted, glass, ACM, polycarbonate.
- Roof slope: 2.5%
- Water drainage: Free fall or with gutter
- Any beam attached to the wall must be anchored to a rigid structure
- Every structure requires civil works, depending on the selected design configuration

Measures

- A. Maximum column height: 9.84 FT
- B. Maximum load-bearing beam width: 19.68 FT
- C. Maximum rafter length: 12.87 FT
- D. Maximum overhang distance for load-bearing beams or rafters: 1.31 FT
- E. Spacing between rafters: 1.97 FT - 2.96 FT
- F. Maximum overhang length for load-bearing beams (cantilevered Pergola): 4.1 FT

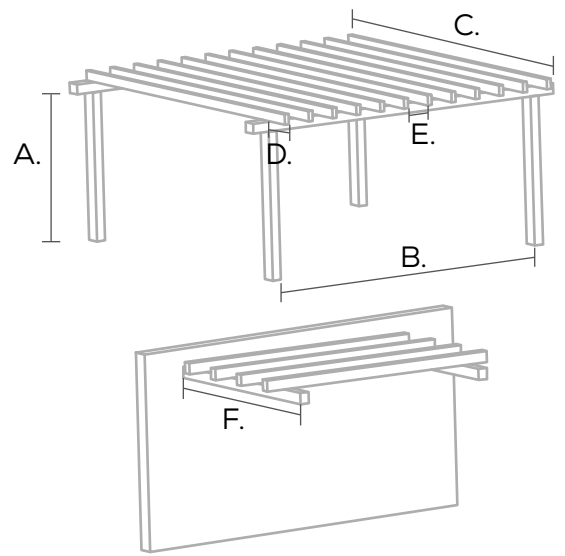

Type of roofing

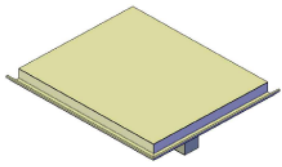

ACM + Gutter

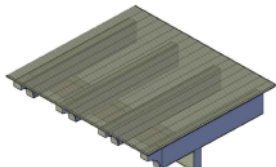

Polycarbonate

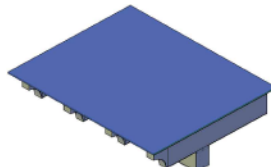

Glass

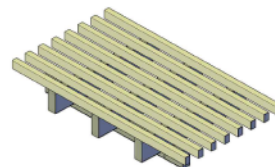

2"x3" Slatted Tube

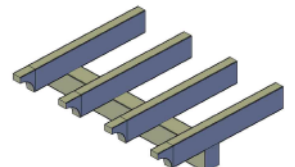

Without roofing

TYPES



Self-supporting



With 1 wall

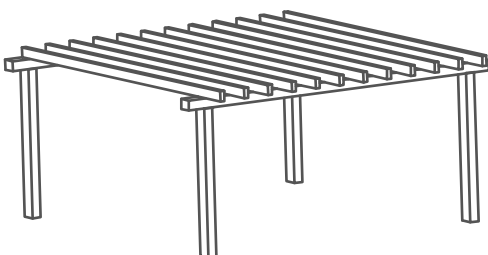

Type 1: Self-supporting

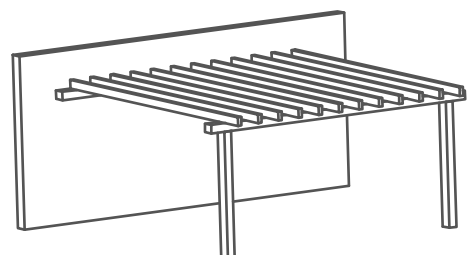

Type 2: With 1 wall



With 2 wall



With 3 wall

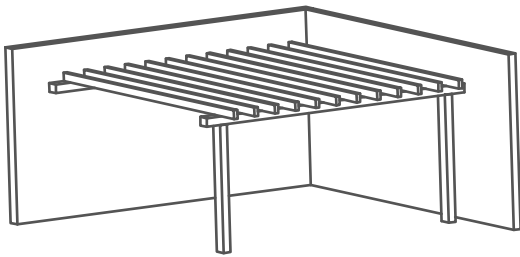

Type 3: With 2 wall

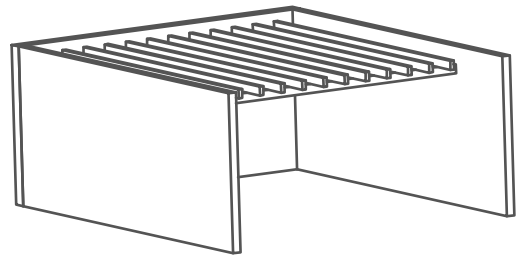

Type 4: With 3 wall



With 4 wall



Overhang

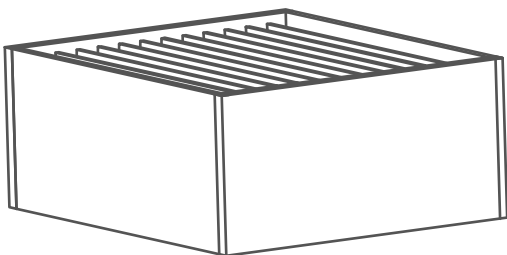

Type 5: With 4 wall

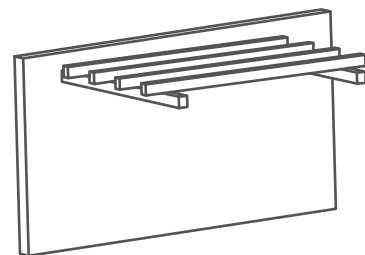

Type 6: Overhang

COLORS

DC01 Bright White

DC02 Silver

DC04 Graphite

DC05 Dark Grey

DC06 Black

DC09 Brown

MA04

MA07

MA08

MA09

MA10

Uni-K
FENESTRATION

+305 420 6910

info@unik-windows.com

  @unik.windows

Download this brochure
with this QR



or visit our website
www.unik-windows.com